

PI 3140 PI 3140

Machine Dimensions Genel Ölçüler

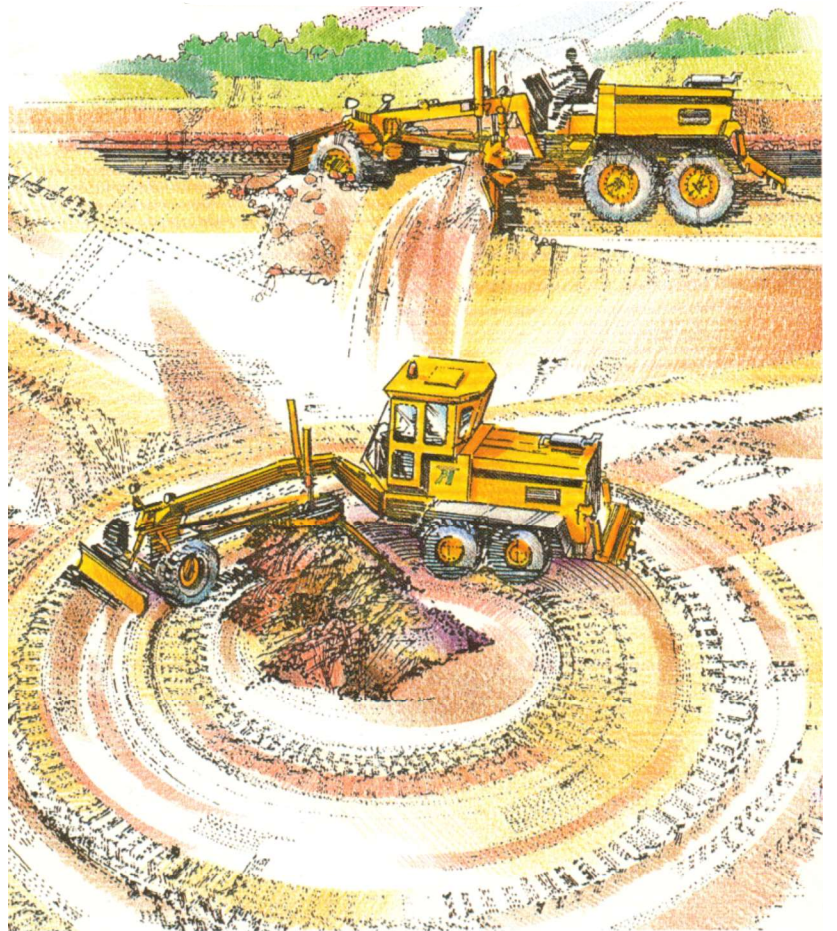

Specifications Özellikler

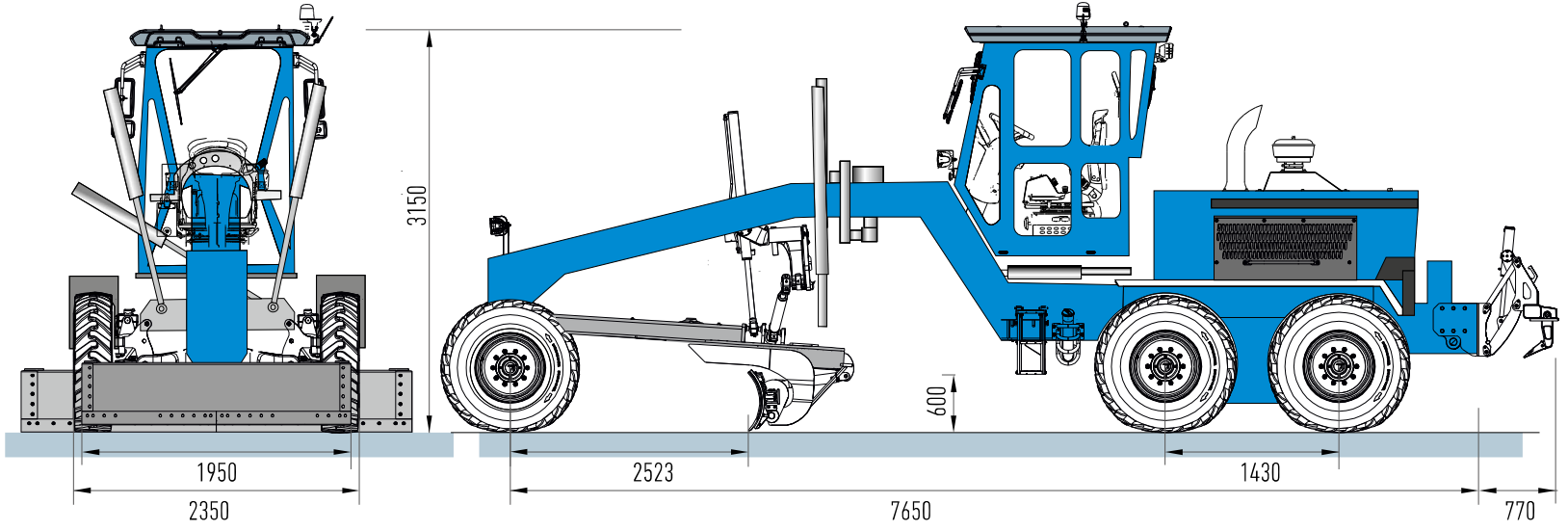

Teknik Özellikler Technical Properties

Çalışma Ağırlığı Operating Weight	11.700 kg
Bıçak Ölçüsü Blade Dimensions	3660 mm
Lastikler Tires	13 x 24 - 10PR



Hidrolik Sistem Hydraulic System

Tip Type	2 Elemanlı Hidrolik Distribütör Basınç Emniyet, Antişok ve Antikavitasyon Valfleri ile komple Hydraulic Distributor with 2 sections complete with Relief Pressure, Antishock and Anticavitation Valves
Pompa Tipi Pump Type	Pistonlu Pompa Piston Pump
Çalışma Basıncı Operating Pressure	140 bar
Kapasite Flow Rate	60 lt per min



Direksiyon Sistemi Steering System

Direksiyon Sistemi Steering System	Hydrostatik direksiyon Hydrostatic Steering
Pompa Tipi Pump Type	Dişli Gear
Çalışma Basıncı Operating Pressure	90 bar
Kapasite Flow Rate	40 lt per min
Dönüş Yarıçapı Steering Radius	7600 mm



Şanzıman

Transmission

Tip Type		Powershift
Hız Speed	1. Vites 1 th Gear	5,7 km/h
Hız Speed	2. Vites 2 nd Gear	8,6 km/h
Hız Speed	3. Vites 3 rd Gear	14,2 km/h
Hız Speed	4. Vites 4 th Gear	21,0 km/h
Hız Speed	5. Vites 5 th Gear	29,8 km/h
Hız Speed	6. Vites 6 th Gear	36,8 km/h



Motor

Engine

Tip Type	Diesel
Hacim Displacement	5880 cm ³ 4 silindir - cylinder
Güç Power	112 kW (152 HP) @ 3500 rpm
Tork Torque	542 Nm @ 1200 - 1250 rpm



Akslar

Axels

Tip Type	6 x 4 Yürüyüş Düzeni 6 x 4 Wheel Drive
Ön Aks Osilasyonu Front Axles Oscillation	± 17°
Arka Aks Rear Axle	Planet Redüksiyonlu Planetary Reduction

