

TRUCK MOUNTED CONCRETE PUMPS KAMYON ÜSTÜ BETON POMPALARI Pi Po K 140.47

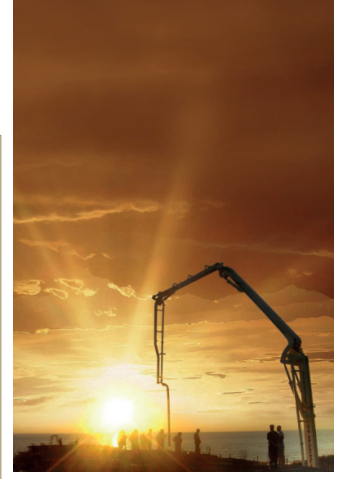
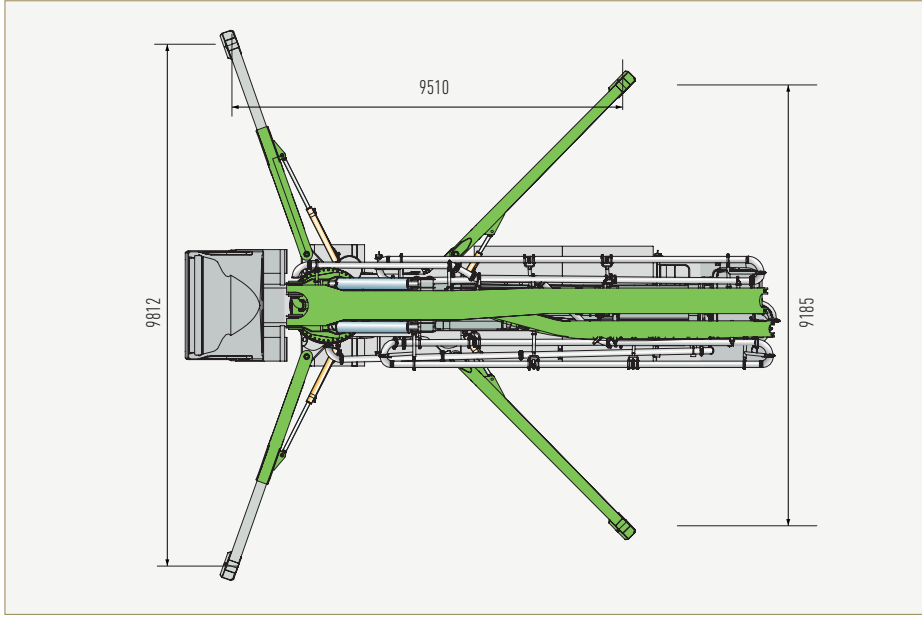
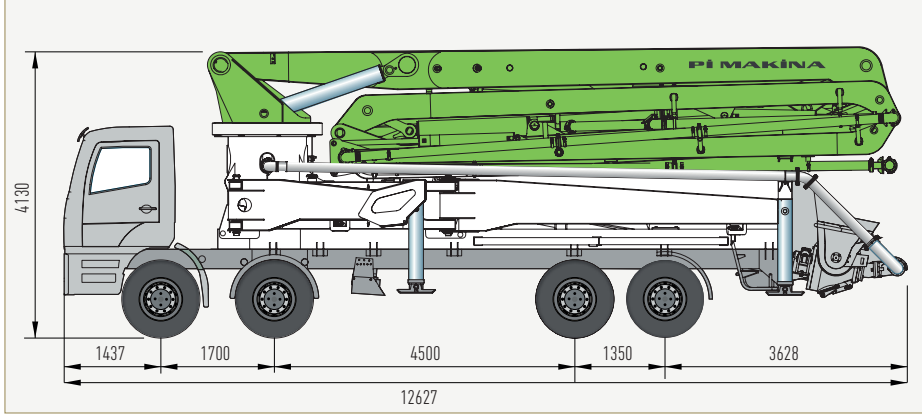

Diagram of 47 m Boom 47 m Bom Diyagramı

