

PI KAM 18 PI KAM 18

4 x 4

Machine Dimensions
Genel Ölçüler

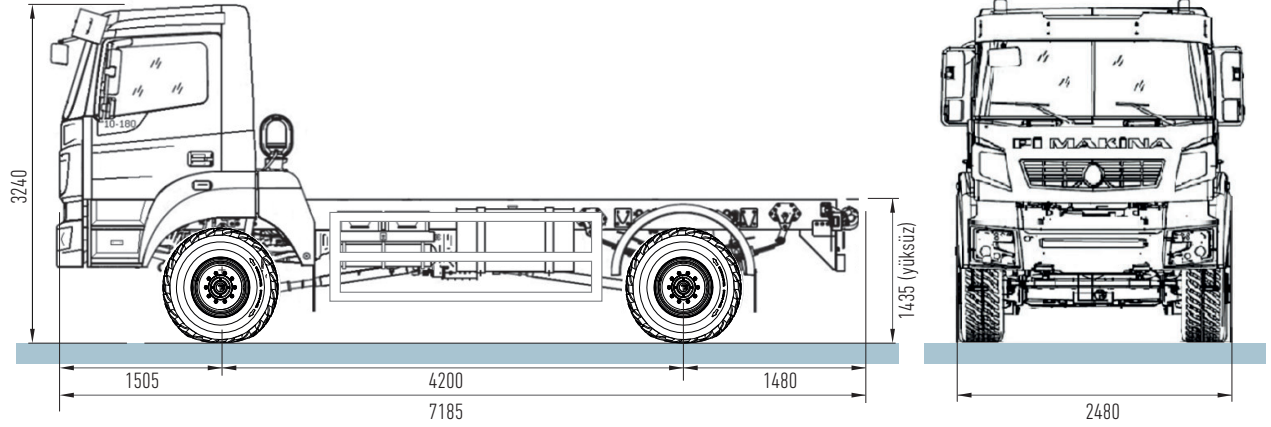

Specifications Özellikler



Kabin Cab

Kabin Tipi Cab Type	Alçak tavan - Sac Kabin Low Ceiling Sheet Metal Cabin
------------------------	--



Motor Engine

Tip Type	Cummins 6 BTA 5.9
Hacim Displacement	6 silindir - cylinder
Güç Power	156 kW (210 HP)
Tork Torque	705 Nm - 1500 rpm



Yakıt Sistemi Fuel System

Yakıt Enjeksiyonu Fuel Injection	Bosch
Yakıt Tankı Fuel Tank	200 Lt.



Şanzıman Transmission

Marka Brand	Eaton
Tip Type	4106 (6+1)



Ara Şanzıman Transfer Gearbox

Marka Brand	Pi Makina
Tip Type	Pi TGB 12 (1:1 - 1:1,83)



Direksiyon Sistemi Steering System

Marka Brand	Hema
Tip Type	Hidrolik Takviyeli Hydraulic Supported



Debriyaj Clutch System

Tip Type	Tek Diskli Single Disc
	Kuru Tip Dry type



Akslar Axels

Ön Aks Front Axle	PİFA 1427 (1:7.15)
Arka Aks Rear Axle	PİRA 1427 (1:7.15)



Elektrik Electric

Arka Aks Rear Axle	24 V (2 x 12V - 165 Ah)
-----------------------	-------------------------



Fren Sistemi Break System

Tip Type	Çift devreli Hidrolik Disk Fren Ön ve Arka disk fren Double Circuit Hydraulic Brake Front and Rear Disc Brake
-------------	--



Süspansiyon Suspension

Ön Makas Tipi Front Springs Type	Hidrolik Amortisör ve Yarı eliptik Makas Hydraulic Shock absorber and semi-elliptical leaf spring
Arka Makas Tipi Rear Springs Type	Hidrolik Amortisör ve Yarı eliptik Makas Hydraulic Shock absorber and semi-elliptical leaf spring



Lastikler ve Jantlar Tyres and Rims

Ön Aks Front Axle	14.00 R20
Arka Aks Rear Axle	4+1



Araç Kapasitesi Vehicle Capacity

Yüksüz Ağırlık Total Weight	7500 kg
Yüklü Ağırlık Loaded Weight	12000 kg
Tırmanma Kabiliyeti Gradeability	31° (%60)
Yükseklik Height	3000 mm ±20
Genişlik Width	2400 mm ±20
Uzunluk Length	7250 mm ±20
Azami Hız Maximum Speed	100 km/h