

TRUCK MOUNTED CONCRETE PUMPS KAMYON ÜSTÜ BETON POMPALARI Pi Po K 140.42

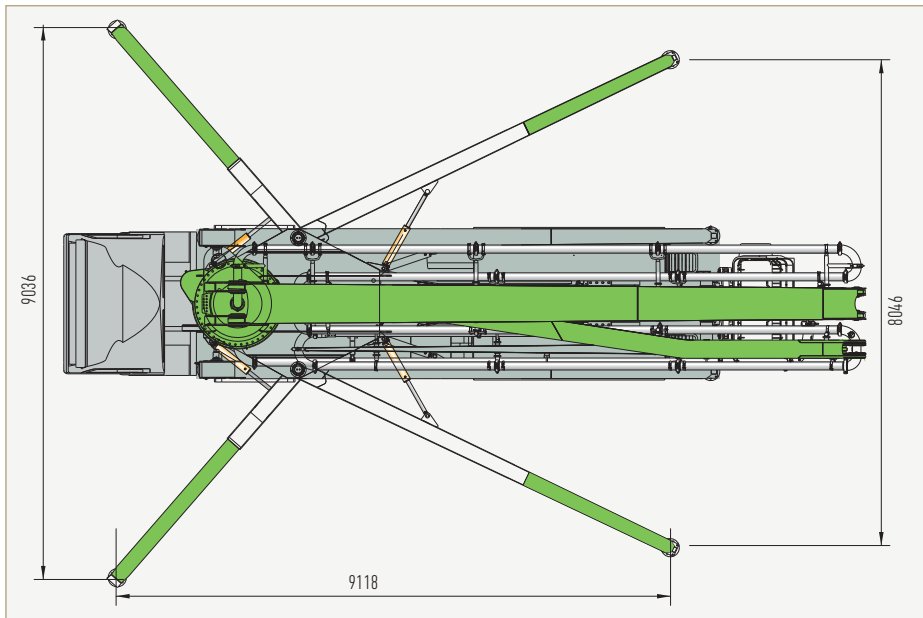
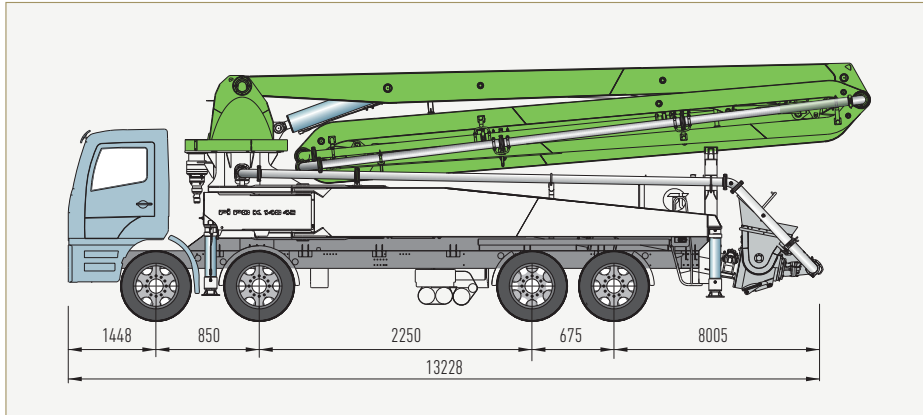

Diagram of 42m Boom

42 m Bom Diyagramı

